

Ink Manufacturing and Printing Solutions



Solutions for pail, drum, or bulk tank ink applications



PROVEN QUALITY. LEADING TECHNOLOGY.

Leading the way in quality ink applications



The industry's most reliable pumps!

Graco is proud to offer the ink industry a complete line of Priming Piston and Diaphragm pumps. They offer a proven reliable design used by ink manufacturers and printers worldwide. Whether you are pumping high or low viscosity fluids from mixing tanks, bins, drums or pails, Graco has the perfect pumping solution!

Features

- Priming piston pumps have flow rates up to 7.5 gpm (28.3 lpm) and are perfect for high viscosity finished ink or ingredient supply
- Husky diaphragm pumps have maximum flow rates of 7-275 gpm (26.5-1,041 lpm), and are ideal for low viscosity finished ink supply or high volume ink transfer
- Priming piston pumps are available with hydraulic or pneumatic motors
- Evacuation from virtually any supply source including bins, drums, pails, dispersion mixers and milling equipment

Key Industries

- Letterpress and lithographic ink manufacturing
- Flexographic and gravure ink manufacturing
- Magazine and commercial printers
- Newspaper printers

Applications

- Supplying ink to press fountains
- Supplying raw ink
- Evacuating to dispersion tanks
- Supplying ink to milling equipment
- Supplying ink to batch dispensing systems
- Waste water treatment
- Pumping solvents for ink wash systems



A complete line of pumps and power sources

Pumps that last!

Whether your specialty is ink manufacturing, printing, or both, it's tough to beat these Graco pumps!

Graco offers a variety of priming piston and diaphragm pumps, for low to high viscosity inks, that are built for years of reliable service. A wide range of pump lowers, motors and mounting configurations guarantee you get the best pump for your application.

Our qualified industrial distributors can expertly combine equipment components and accessories tailored to fit any setup.

Husky™ Air-Operated Double Diaphragm pumps

- Ideal for flexographic and gravure ink
- High volume transfer, supply of mixing ingredients and ink packaging
- Unloading dispersion mixers, supplying milling equipment and batch metering of ingredients
- No exposed seal to wear or leak
- Handles low to medium viscosity fluids with ease



Priming Piston pumps™

- Ideal for printing with letterpress or lithographic inks, and ingredient supply in ink manufacturing
- Available with hydraulic or pneumatic motors
- Improved seal design reduces leakage
- Handles high viscosity fluids with ease
- Mounts on powerful pneumatic rams, carts or floor stands
- Compatible with UV inks



Hydraulic or Pneumatic?

Graco offers both hydraulic and pneumatic motors to drive your priming piston pump. Both are top quality choices for smooth, continuous ink delivery.

Pneumatic Motors

Graco's King®, Bulldog®, Senator® and President® pneumatic motors provide rugged, reliable service life for ink manufacturing and printing applications.



King Pneumatic Motor

Hydraulic Motors

When paired with any of Graco's priming piston pumps, the Viscount® II hydraulic motor offers exceptional cost savings by operating on 20% of the energy used by pneumatic motors.



Viscount II Hydraulic Motor

ALREADY OWN A PNEUMATIC MOTOR?

No problem! Take advantage of significant savings by converting your existing pump to a Graco hydraulic system. See your Graco Distributor for details.

SAVE UP TO 80% ON ENERGY COSTS WHEN YOU CHOOSE HYDRAULIC!

Diaphragm pumps for ink supply and transfer

IDEAL FOR: INK MANUFACTURERS & PRINTERS

- Supply of flexographic and gravure inks, or transfer of letterpress or lithographic inks
- Evacuation of dispersion tanks or supply to milling equipment
- Batch metering of ingredients
- Transferring solvents used in press wash systems

Supply or transfer with ease!

Husky Air-Operated Double Diaphragm pumps are ideal for bulk transfer of your solvent or water-based, low to medium viscosity inks and ingredients. They offer easy maintenance with an extremely reliable patented air valve for true non-sticking operation.

FEATURES

- Sizes range from 3/8 in (9.52 mm) to 3 in (76.2 mm)
- Flow rates from 7 - 275 gpm (26.5 - 1,041 lpm)
- Polypropylene, acetal, aluminum and stainless steel materials of construction
- Patented dual cup air valve design resists icing, sticking, and requires no external lubrication
- Fewer moving parts means increased durability
- 3/8 in and 1/2 in sizes are available with single or dual inlet/outlet configurations
- All pumps have a 5-year warranty on the fluid end and a 15 year warranty on the center section



A WIDE RANGE OF SIZES AND FLOW RATES!



HUSKY

Selection Guide

We've got the solution!

Proven reliable across many industries, Husky Air-Operated Double Diaphragm pumps expertly supply and transfer fluids in both ink printing and manufacturing. With seven sizes and four materials of construction, Graco has a pumping solution perfect for your application!

Graco's large ported, high volume diaphragm pumps efficiently evacuate dispersion tanks, or supply material to milling equipment in ink manufacturing. Smaller, more portable Husky designs are better suited for batch dispensing high volume, low viscosity materials.

MANUFACTURING

LITHOGRAPHIC AND LETTERPRESS INKS

	Up to 7 gpm (26 lpm) 64 lb/min* (29 kg/min)	Up to 15 gpm (56 lpm) 137 lb/min* (62 kg/min)	Up to 40 gpm (151 lpm) 366 lb/min* (166 kg/min)	Up to 75 gpm (283 lpm) 687 lb/min* (311 kg/min)
5,000 cps	Husky 515 Husky 716	Husky 1040	Husky 1590 Husky 2150	Husky 2150 Husky 3275
10,000 cps	Husky 1040	Husky 1590 Husky 2150	Husky 2150 Husky 3275	Husky 3275
20,000 cps	Husky 2150	Husky 2150	Husky 3275	

*Assumes specific gravity of 1.1

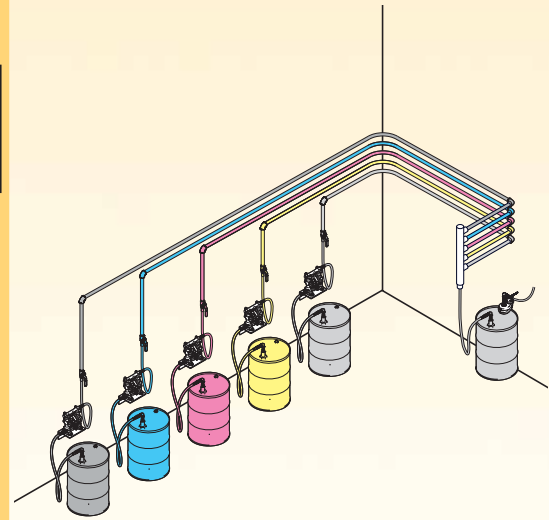

Supplying flexographic or gravure inks to printing fountains requires small, more portable Husky pumps that circulate the ink at a desired flow. Choose a pump with a dual inlet/outlet for added flexibility.

PRINTING

FLEXOGRAPHIC AND GRAVURE INKS

	Up to 7 gpm (26 lpm) 58 lb/min* (29 kg/min)	Up to 15 gpm (56 lpm) 125 lb/min* (56 kg/min)	Up to 40 gpm (151 lpm) 333 lb/min* (151 kg/min)	Up to 75 gpm (283 lpm) 625 lb/min* (283 kg/min)
60-80 cps	Husky 307**	Husky 515** Husky 716	Husky 1040	Husky 1590 Husky 2150 Husky 3275

*Assumes specific gravity of 1.0

** Indicates an available dual inlet/outlet configuration

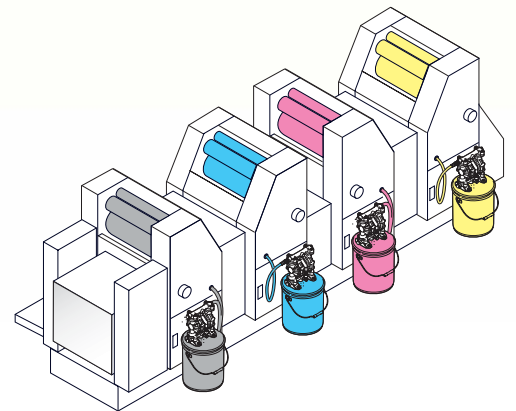

Schematics are representative of typical system set-ups

Piston pumps for letterpress & lithographic inks

IDEAL FOR: INK MANUFACTURERS & PRINTERS

- Low to high volume multiple press printers using letterpress or lithographic inks
- Ingredient supply to dispersion mixers
- Custom UV ink packages available

Pumping your highest volumes and viscosities!

With higher pump pressures and flow rates, Graco priming piston pumps handle a broad range of inks with ease. They offer durability, power and reliability in any ink manufacturing or printing application.

FEATURES

- Three priming piston pump sizes – 450 (1.2 gpm), 800 (2.8 gpm) and 2100 (7.5 gpm)
- Maximum pressures of 3100 psi (213 bar) when paired with one of five motors
- Positive displacement, priming piston design provides uniform and easily-controlled delivery
- Extremely durable pump with long-life packing design, and low maintenance
- Evacuates from pails, drums and bins with ease



A SOLUTION FOR ANY SETUP!

Available with hydraulic or pneumatic motors!



Floor Mount
12:1 Bulldog with
2100 pump

BINS

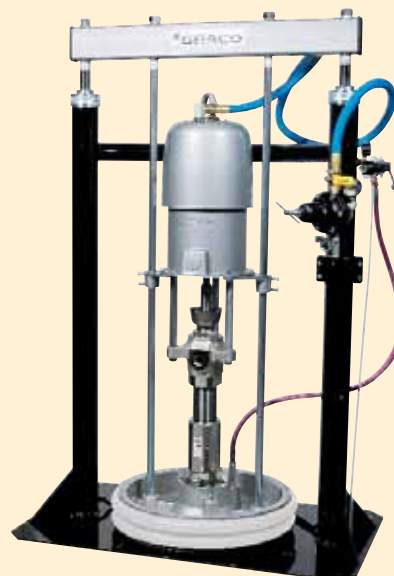

Ram Mount
31:1 Bulldog with
800 pump

DRUMS



Cart Mount
10:1 President with
450 pump

PAILS

The ultimate choice in power sources!

POWER

We've got the power!

When it comes to the power source to drive your priming piston pump, Graco leads the competition in technology and innovation. We offer a selection of top-quality pneumatic and hydraulic motors perfect for any application. The Viscount II, Graco's patented hydraulic motor, is also proven to provide substantial annual savings. Whatever motor you choose, Graco can outfit your operation!



KING

- Produces up to 2400 psi (165 bar) when mounted to a 2100 pump



BULLDOG

- Produces up to 1200 psi (82 bar) when mounted to a 800 pump and 3100 psi (231 bar) when mounted to a 2100 pump



SENATOR

- Produces up to 1900 psi (130 bar) when mounted to a 800 pump



PRESIDENT

- Produces up to 1000 psi (68 bar) when mounted to a 450 pump



VISCOUNT II

- Replaces the King, Bulldog or Senator motors with the 800 or 2100 pump

PNEUMATIC

HYDRAULIC

**SAVES UP TO 80%
ON ENERGY!**

Check out the Return-On-Investment Analysis to learn how you can start saving with a Graco Viscount II hydraulic powered system!



Selection Guide

Choose the right pump for your application

Whether you are supplying ink ingredients to a dispersion mixer or finished inks to your printing press, Graco has a pumping solution! Choose from our complete selection of pumps and packages for transferring from pails, drums and bins.

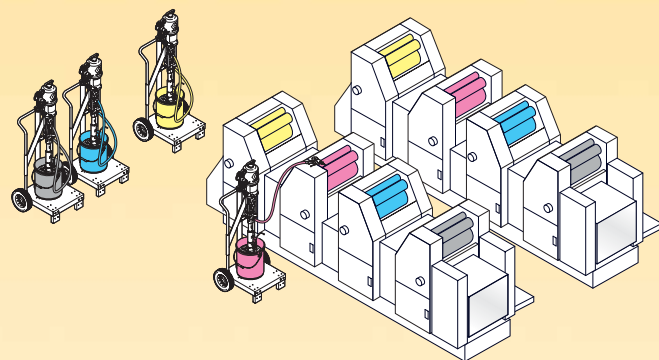

PAILS

Up to 1 gpm
(3.7 lpm)
9.6 lb/min*
(4.3 kg/min)

- 10:1 President

*Assumes specific gravity of 1.1

DRUMS

Up to 1 gpm
(3.7 lpm)
9.6 lb/min*
(4.3 kg/min)

- 10:1 President

Up to 2.8 gpm
(10.5 lpm)
27.5 lb/min*
(12.4 kg/min)

- 19:1 Senator
- Viscount II 1900
- 31:1 Bulldog
- Viscount II 3100

Up to 7.5 gpm
(28.3 lpm)
73 lb/min*
(33.1 kg/min)

- 12:1 Bulldog
- Viscount II 1200
- 24:1 King
- Viscount II 2400

*Assumes specific gravity of 1.1

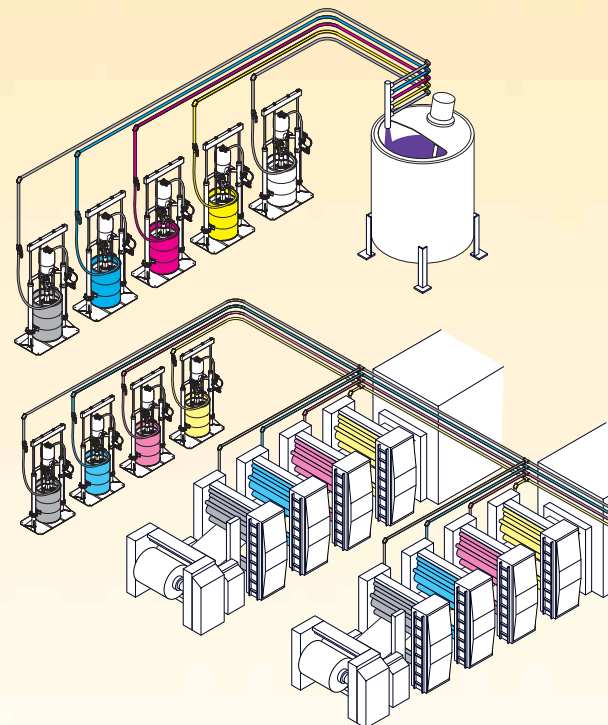

BINS

Up to 1 gpm
(3.7 lpm)
9.6 lb/min*
(4.3 kg/min)

- 19:1 Senator
- Viscount II 1900
- 31:1 Bulldog
- Viscount II 3100

Up to 2.8 gpm
(10.5 lpm)
27.5 lb/min*
(12.4 kg/min)

- 19:1 Senator
- Viscount II 1900
- 31:1 Bulldog
- Viscount II 3100

Up to 7.5 gpm
(28.3 lpm)
73 lb/min*
(33.1 kg/min)

- 12:1 Bulldog
- Viscount II 1200
- 24:1 King
- Viscount II 2400

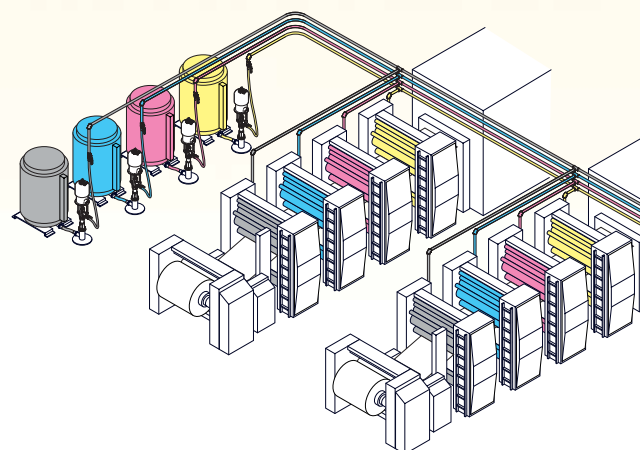

Schematics are representative of typical system set-ups

Cost savings that are hard to beat

Choose hydraulic and save!

Unlike pneumatic, hydraulic motors continually reuse the oil required to cycle the motor, making hydraulic technology the most efficient solution for pumping ink!

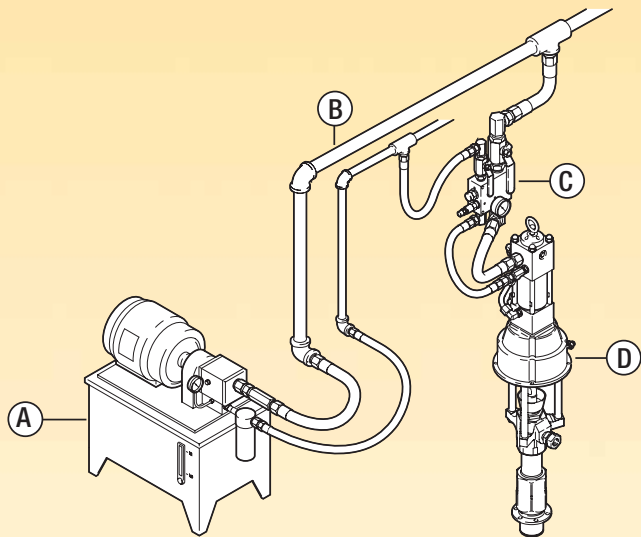

- A. Hydraulic power pack** – Consists mainly of oil reservoir, electric motor and variable volume/pressure-compensated hydraulic pump.
- B. Supply and return lines** – Supplies high pressure oil to the hydraulic ink pump and returns the used oil.
- C. Hydraulic regulator and flow control** – Controls the pressure and flow of oil to the hydraulic motor which, in turn, controls the outlet pressure and cycle rate of the ink pump.
- D. Hydraulic motor** – The Viscount II uses a controlled volume of oil, at a specific pressure, to duplicate the fluid flow and pressures in a pneumatic system. The controlled oil is then circulated back to the power pack for reuse.

Note: Pneumatic motors exhaust the compressed air into the atmosphere after cycling the pump.

TYPICAL SETUP

HYDRAULIC CONVERSION KIT

Convert your pneumatic pump to a Viscount II hydraulic pump today! Just contact your Graco Distributor and ask for part number 15D433.

RETURN-ON-INVESTMENT ANALYSIS

PNEUMATIC PUMPS		HYDRAULIC PUMPS	
2000 psi pneumatic pump @ 100 psi inlet air pressure		2000 psi hydraulic pump @ 1300 psi inlet oil pressure	
Number of pumps	4	4	Number of pumps
Total ink pumped per day per pump (gal)	1,200	1,200	Total ink pumped per day per pump (gal)
Total ink used per day	4,800	4,800	Total ink per day
CFM of air per gallon of ink	18 cfm	1.60 gal	Gallon of oil per gallon of ink
Total CFM = CFM/gal x total ink used per day	86,400 cfm	7,680 gal	Total oil = gallons of oil per gallon of ink x total ink used per day
Horsepower (hp) = total cfm ÷ 4	21,600 hp	6,853 hp	Horsepower = (maximum oil pressure x total oil) ÷ (1714 x 0.85)
Daily power consumption (kW/hr) = total hp ÷ 7.46	2,895 kW/hr	919 kW/hr	Daily power consumption (kW/hr) = total hp ÷ 7.46
Energy cost = daily power consumption x kW rate	\$180.97	\$57.41	Energy cost = daily power consumption x kW rate
Daily energy cost savings	\$123.56		
Production days per year	365		
ANNUAL ENERGY SAVINGS USING HYDRAULICS	\$45,096		

Kilowatt rate of \$0.06 is used in calculation

ROI

Technical Specifications and Ordering Information

Air-Operated Double Diaphragm Pumps

Pump Type

Fluid inlet and outlet size	3/8" (9.52 mm)
Maximum free flow delivery	7 gpm (26.5 lpm)
Displacement per cycle	0.02 gallon (0.076 liter)
Air inlet size	1/4" npt (f)
Air pressure operating range	20-100 psi (1.3-7 bar)
Maximum air consumption	6 scfm
Maximum size of pumpable solids	0.006 in (1.5 mm)
Maximum operating temperature	PTFE 220°F, Buna-N 180°F, Hytrel 150°F
Typical sound level	75 dBa
Instruction manual	308553

Husky 307



Husky 307 Acetal



Husky 307 Polypropylene

Ordering Information for Husky 307

Part Number		Material of Construction	Seats	Balls	Diaphragm	Dual Inlet/Outlet
NPT Ported	BSP Ported					
D31277	D3A277	Acetal	Acetal	Buna-N	Buna-N	
248167		Acetal	Acetal	Buna-N	Buna-N	Yes
D31255	D3A255	Acetal	Acetal	Hytrel	Hytrel	
248168		Acetal	Acetal	Hytrel	Hytrel	Yes
D31311	D3A311	Acetal	SST	PTFE	PTFE	
D32255	D3B255	Poly	Acetal	Hytrel	Hytrel	
248169		Poly	Acetal	Hytrel	Hytrel	Yes
D32977	D3B977	Poly	Poly	Buna-N	Buna-N	
248170		Poly	Poly	Buna-N	Buna-N	Yes
D32311	D3B211	Poly	SST	PTFE	PTFE	

Please consult the Process Equipment Buyer's Guide (300435) for additional configurations.

Pump Type

Fluid inlet and outlet size	1/2" (12.7 mm)
Maximum free flow delivery	15 gpm (57 lpm)
Displacement per cycle	0.04 gallon (0.15 liter)
Air inlet size	1/4" npt (f)
Air pressure operating range	25-100 psi (1.7-7 bar)
Maximum air consumption	28 scfm
Maximum size of pumpable solids	0.09 in (2.5 mm)
Maximum operating temperature	PTFE 220°F, Buna-N 180°F, Hytrel 150°F, Santoprene 180°F
Typical sound level	74 dBa
Instruction manual	308981

Husky 515



Husky 515 Acetal



Husky 515 Polypropylene

Ordering Information for Husky 515

Part Number		Material of Construction	Seats	Balls	Diaphragm	Dual Inlet/Outlet
NPT Ported	BSP Ported					
D51277	D5A277	Acetal	Acetal	Buna-N	Buna-N	
248171		Acetal	Acetal	Buna-N	Buna-N	Yes
D51255	D5A255	Acetal	Acetal	Hytrel	Hytrel	
248172		Acetal	Acetal	Hytrel	Hytrel	Yes
D51311	D5A311	Acetal	SST	PTFE	PTFE	
D52955	D5B955	Poly	Poly	Hytrel	Hytrel	
248174		Poly	Poly	Hytrel	Hytrel	Yes
D52977	D5B977	Poly	Poly	Buna-N	Buna-N	
248173		Poly	Poly	Buna-N	Buna-N	Yes
D52311	D5B311	Poly	SST	PTFE	PTFE	
D51D05	D5AD05	Acetal	Duckbill	—	Hytrel	
D52966	D5B966	Poly	Poly	Santoprene	Santoprene	
D52D05	D5BD05	Poly	Duckbill	—	Hytrel	
D52D07	D5BD07	Poly	Duckbill	—	Buna-N	

Please consult the Process Equipment Buyer's Guide (300435) for additional configurations.



Husky 515 Polypropylene Dual Inlet/Outlet

Technical Specifications and Ordering Information

Husky 716

Fluid inlet and outlet size	3/4"(19.05 mm)
Maximum free flow delivery	16 gpm (61 lpm)
Displacement per cycle	0.04 gallon (0.15 liter)
Air inlet size	1/4" npt (f)
Air pressure operating range	25-100 psi (1.7-7 bar)
Maximum air consumption	.28 scfm
Maximum size of pumpable solids	0.09 in (2.5 mm)
Maximum operating temperature	PTFE 220°F, Buna-N 180°F, Hytrel 150°F, Santoprene 180°F
Typical sound level	.74 dBa
Instruction manual	.308981



Husky 716 Aluminum

Ordering Information for Husky 716

Part Number		Material of Construction	Seats	Balls	Diaphragm
NPT Ported	BSP Ported				
D53255	D5C255	Aluminum	Acetal	Hytrel	Hytrel
D53277	D5C277	Aluminum	Acetal	Buna-N	Buna-N
D53311	D5C311	Aluminum	SST	PTFE	PTFE
D53331	D5C331	Aluminum	SST	SST	PTFE
D54311	D5D311	SST	SST	PTFE	PTFE
D54331	D5D331	SST	SST	SST	PTFE
D54377	D5D377	SST	SST	Buna-N	Buna-N
D53D05	D5CD05	Aluminum	Duckbill	–	Hytrel
D53966	D5C966	Aluminum	Poly	Santoprene	Santoprene
D53D05	D5CD05	Aluminum	Duckbill	–	Hytrel
D53D07	D5CD07	Aluminum	Duckbill	–	Buna-N

Please consult the Process Equipment Buyer's Guide (300435) for additional configurations.



Husky 716 Stainless Steel

Husky 1040

Fluid inlet and outlet size	1" (25.4 mm) npt
Maximum free flow delivery	40 gpm (151 lpm)
Displacement per cycle	0.15 gallon (0.57 liter)
Air inlet size	1/2" npt (f)
Air pressure operating range	20-120 psi (1.3-8 bar)
Maximum air consumption	.60 scfm
Maximum size of pumpable solids	0.13 in (3.2 mm)
Maximum operating temperature	PTFE 220°F, Buna-N 180°F
Typical sound level	.76 dBa
Instruction manual	.308443



Husky 1040 Aluminum

Ordering Information for Husky 1040

Part Number		Material of Construction	Seats	Balls	Diaphragm
NPT Ported	BSP Ported				
D73311	D7C311	Aluminum	SST	PTFE	PTFE
D73331	D7C331	Aluminum	SST	SST	PTFE
D73337	D7C337	Aluminum	SST	SST	Buna-N
D73377	D7C377	Aluminum	SST	Buna-N	Buna-N
D73777	D7C777	Aluminum	Buna-N	Buna-N	Buna-N
D74311	D7D311	SST	SST	PTFE	PTFE
D74331	D7D331	SST	SST	SST	PTFE
D74337	D7D337	SST	SST	SST	Buna-N
D74377	D7D377	SST	SST	Buna-N	Buna-N
D74777	D7D777	SST	Buna-N	Buna-N	Buna-N

Please consult the Process Equipment Buyer's Guide (300435) for additional configurations.



Husky 1040 Stainless Steel

Technical Specifications and Ordering Information

Husky 1590

Fluid inlet and outlet size	1-1/2" (38.1 mm)
Maximum free flow delivery	100 gpm (378.5 lpm)
Displacement per cycle	0.50 gallon (1.96 liter)
Air inlet size	1/2" npt (f)
Air pressure operating range	20-120 psi (1.3-8 bar)
Maximum air consumption	125 scfm
Maximum size of pumpable solids	0.19 in (4.8 mm)
Maximum operating temperature	PTFE 220°F, Buna-N 180°F
Typical sound level	76 dBa
Instruction manual	308549



Husky 1590 Aluminum

Ordering Information for Husky 1590

Part Number		Material of Construction	Seats	Balls	Diaphragm
NPT Ported	BSP Ported				
DB3311	DBC311	Aluminum	SST	PTFE	PTFE
DB3341	DBC341	Aluminum	SST	Hardened SST	PTFE
DB3347	DBC347	Aluminum	SST	Hardened SST	Buna-N
DB3377	DBC377	Aluminum	SST	Buna-N	Buna-N
DB3777	DBC777	Aluminum	Buna-N	Buna-N	Buna-N
DB4311	DBD311	SST	SST	PTFE	PTFE
DB4341	DBD341	SST	SST	Hardened SST	PTFE
DB4347	DBD347	SST	SST	Hardened SST	Buna-N
DB4377	DBD377	SST	SST	Buna-N	Buna-N
DB4777	DBD777	SST	Buna-N	Buna-N	Buna-N

Please consult the Process Equipment Buyer's Guide (300435) for additional configurations.



Husky 1590 Stainless Steel

Husky 2150

Fluid inlet and outlet size	2" (50.8 mm)
Maximum free flow delivery	150 gpm (568 lpm)
Displacement per cycle	1.03 gallon (3.90 liter)
Air inlet size	1/2" npt (f)
Air pressure operating range	20-120 psi (1.3-8 bar)
Maximum air consumption	175 scfm
Maximum size of pumpable solids	0.25 in (6.3 mm)
Maximum operating temperature	PTFE 220°F, Buna-N 180°F
Typical sound level	78 dBa
Instruction manual	308550



Husky 2150 Aluminum

Ordering Information for Husky 2150

Part Number		Material of Construction	Seats	Balls	Diaphragm
Ported NPT	Ported BSP				
DF3311	DFC311	Aluminum	SST	PTFE	PTFE
DF3341	DFC341	Aluminum	SST	Hardened SST	PTFE
DF3347	DFC347	Aluminum	SST	Hardened SST	Buna-N
DF3377	DFC377	Aluminum	SST	Buna-N	Buna-N
DF3777	DFC777	Aluminum	Buna-N	Buna-N	Buna-N
DF4311	DFD311	SST	SST	PTFE	PTFE
DF4341	DFD341	SST	SST	Hardened SST	PTFE
DF4347	DFD347	SST	SST	Hardened SST	Buna-N
DF4377	DFD377	SST	SST	Buna-N	Buna-N
DF4777	DFD777	SST	Buna-N	Buna-N	Buna-N

Please consult the Process Equipment Buyer's Guide (300435) for additional configurations.



Husky 2150 Stainless Steel

Technical Specifications and Ordering Information

Husky 3275

Fluid inlet and outlet size	3" (76.22 mm)
Maximum free flow delivery	275 gpm (1,041 lpm)
Displacement per cycle	2.0 gallon (7.6 liter)
Air inlet size	3/4" npt(f)
Air pressure operating range	20-120 psi (1.3-8 bar)
Maximum air consumption	325 scfm
Maximum size of pumpable solids	0.25 in (6.3 mm)
Maximum operating temperature	PTFE 220°F, Geolast 150°F, Hytrel 150°F
Typical sound level	.79 dBA
Instruction manual	.308639



Husky 3275 Aluminum

Ordering Information for Husky 3275

Part Number		Material of Construction	Seats	Balls	Diaphragm
Ported NPT	Ported BSP				
DK3311	DKC311	Aluminum	SST	PTFE	PTFE
DK3525	DKC525	Aluminum	Hytrel	Acetal	Hytrel
DK3GGG	DKCGGG	Aluminum	Geolast	Geolast	Geolast

Please consult the Process Equipment Buyer's Guide (300435) for additional configurations.

Piston Pumps

Name of Pump	President 20:1
Lower size	450
Maximum fluid pressure	2000 psi (140 bar, 14 MPa)
Maximum motor inlet pressure	100 psi (7 bar, 0.7 MPa)
Flow rate @ 60 cpm	1.2 gpm (4.5 lpm)
Cfm or gpm required per gallon	35 cfm
Fluid pump outlet size	3/4" npt (f)
Motor inlet size	1/2" npt (f)
Weight of pump	50 lb (22.7 kg)
Instruction manual	308017

Bin Supply

Pump	246933
Air controls: FRL, 3/8"(f)	110150
Floor stand (3" inlet)	222780
Air run away control, 3/4"(f)	224040
Air speed control 1/2"(f)	510441

55-gallon drum supply

Ram package with pump and air regulator	234369
Air run away control, 3/4"(f)	224040
Air speed control, 1/2"(f)	510441

5-gallon pail supply

Cart package with pump	234370
Air run away control, 3/4"(f)	224040
Air speed control, 1/2"(f)	510441

Misc. information

Pump lower section	246932
Ram plate replacement seals	165601

Please consult the Accessories Buyer's Guide (303119) for additional accessories.



10:1 President



10:1 President
on 5 gallon cart

Technical Specifications and Ordering Information

Name of Pump	Senator 19:1	Viscount II 1900	Bulldog 31:1	Viscount II 3100
Lower size	800	800	800	800
Maximum fluid pressure	1900 psi (131 bar, 13.1 MPa)	1900 psi (131 bar, 13.1 MPa)	3100 psi (213 bar, 21.3 MPa)	3100 psi (213 bar, 21.3 MPa)
Maximum motor inlet pressure	100 psi (air) (6.9 bar, 0.69 MPa)	450 psi (oil) (31 bar, 3.1 MPa)	100 psi (air) (6.9 bar, 0.69 MPa)	750 psi (oil) (51.7 bar, 5.1 MPa)
Flow rate @ 60 cpm	2.8 gpm (10.6 lpm)	2.8 gpm (10.6 lpm)	2.8 gpm (10.6 lpm)	2.8 gpm (10.6 lpm)
Cfm or gpm required per gallon	24 cfm	4.3 gpm (16.2 lpm)	32 cfm	4.3 gpm (16.2 lpm)
Fluid pump outlet size	1" npt (f)	1" npt (f)	1" npt (f)	1" npt (f)
Motor inlet size	3/4" npt (f)	3/4" npt (f)	3/4" npt (f)	3/4" npt (f)
Weight of pump	160 lb (73 kg)	177 lb (80 kg)	160 lb (73 kg)	177 lb (80 kg)
Instruction manual	308351	308351	308351	308351

Bin Supply	Senator 19:1	Viscount II 1900	Bulldog 31:1	Viscount II 3100
Pump	246941	246938	246940	246938
Air controls: FRL, 1/2"	217072		217072	
Air run away control, 3/4"	224040		224040	
Air speed control, 1/2"(f)	510441		510441	
Floor stand (3" inlet)	222780	222780	222780	222780
Hydraulic controls*		236865		236865
Outlet hydraulic hose connector 1"(m) x 1-1/2"(f), 1500 psi rated		Not included		Not included

55-Gallon Drum Supply	Senator 19:1	Viscount II 1900	Bulldog 31:1	Viscount II 3100
Ram package with pump	234377	234378	234374	234378
Air run away control, 3/4"	224040		224040	
Air speed control, 1/2"	510441		510441	
Hydraulic controls*		236865		236865
Outlet hydraulic hose connector 1"(m) x 1-1/2"(f), 1500 psi rated		Not included		Not included

Misc. Information	Senator 19:1	Viscount II 1900	Bulldog 31:1	Viscount II 3100
Pump lower section	246939	246939	246939	246939
Ram plate replacement seals	165601	165601	165601	165601

*Hydraulic controls include hydraulic flow and pressure control, ball valves, 3 ft supply and return hose
Please consult the Accessories Buyer's Guide (303119) for additional accessories.

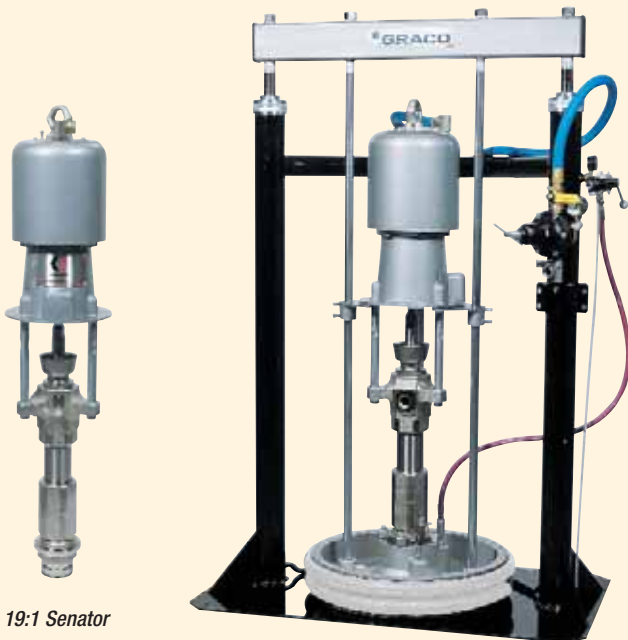

19:1 Senator

19:1 Senator on
55 gallon ram

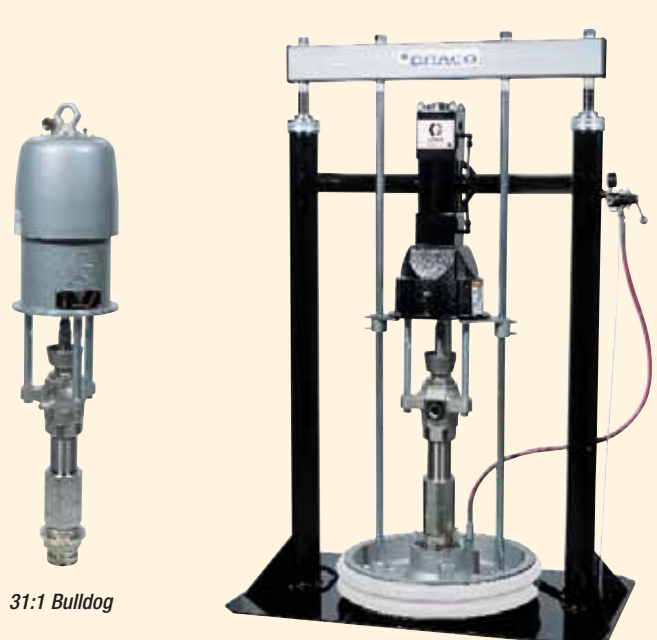

31:1 Bulldog

Viscount II 3100 on
55 gallon ram

Technical Specifications and Ordering Information

Name of Pump	Bulldog 12:1	Viscount II 1200	King 24:1	Viscount II 2400
Lower size	2100	2100	2100	2100
Maximum fluid pressure	1200 psi (82.8 bar, 8.28 MPa)	1200 psi (82.8 bar, 8.28 MPa)	2400 psi (165 bar, 16.5 MPa)	2400 psi (165 bar, 16.5 MPa)
Maximum motor inlet pressure	100 psi (air) (6.9 bar, 0.69 MPa)	750 psi (oil) (51.7 bar, 5.1 Mpa)	100 psi (air) (6.9 bar, 0.69 Mpa)	1500 psi (oil) (103 bar, 10.3 Mpa)
Flow rate @ 60 cpm	7.5 gpm (28.4 lpm)	7.5 gpm (28.4 lpm)	7.5 gpm (28.4 lpm)	7.5 gpm (28.4 lpm)
Cfm or gpm required per gallon	20 cfm	1.6 gpm (6 lpm)	25 cfm	1.6 gpm (6 lpm)
Fluid pump outlet size	1-1/2" npt (m)	1-1/2" npt (m)	1-1/2" npt (m)	1-1/2" npt (m)
Motor inlet size	3/4" npt (f)	3/4" npt (f)	3/4" npt (f)	3/4" npt (f)
Weight of pump	142 lb (65 kg)	196 lb (89 kg)	160 lb (73 kg)	196 lb (89 kg)
Instruction manual	308149	308149	308149	308149

Bin Supply	Bulldog 12:1	Viscount II 1200	King 24:1	Viscount II 2400
Pump	246935	246937	246936	246937
Air controls: FRL, 1/2"	217072		217072	
Air run away control, 3/4"	224040		224040	
Air speed control, 1/2"(f)	510441		510441	
Floor stand (3" inlet)	222780	222780	222780	222780
Hydraulic controls*		236865		236865
Outlet hydraulic hose connector 1"(m) x 1-1/2" (f), 1500 psi rated		Not included		Not included

55-Gallon Drum Supply	Bulldog 12:1	Viscount II 1200	King 24:1	Viscount II 2400
Ram package with pump	234371	234376	234372	234376
Air run away control, 3/4"	224040		224040	
Air speed control, 1/2"(f)	510441		510441	
Hydraulic controls*		236865		236865
Outlet hydraulic hose connector 1"(m) x 1-1/2" (f), 1500 psi rated		Not included		Not included

Misc. Information	Bulldog 12:1	Viscount II 1200	King 24:1	Viscount II 2400
Pump lower section	246934	246934	246934	246934
Ram plate replacement seals	165601	165601	165601	165601

*Hydraulic controls include hydraulic flow and pressure control, ball valves, 3 ft supply and return hose

Please consult the Accessories Buyer's Guide (303119) for additional accessories.



12:1 Bulldog



Viscount II 2100



24:1 King

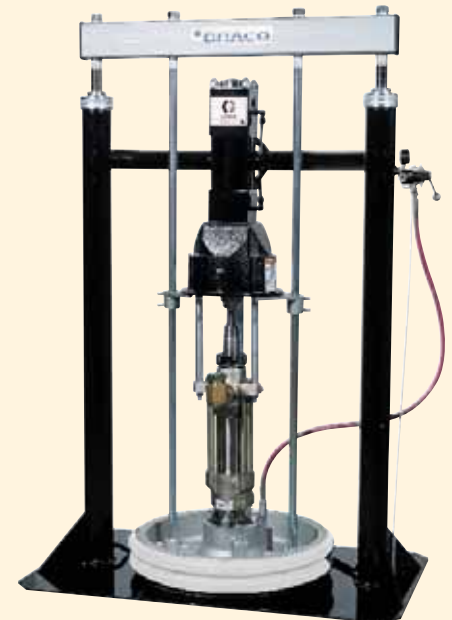

Viscount II 2400 on
55 gallon ram

ABOUT GRACO

PROVEN QUALITY. LEADING TECHNOLOGY.

Founded in 1926, Graco is a world leader in fluid handling systems and components. Graco products move, measure, control, dispense and apply a wide range of fluids and viscous materials used in vehicle lubrication, commercial and industrial settings.

The company's success is based on its unwavering commitment to technical excellence, world-class manufacturing and unparalleled customer service. Working closely with qualified distributors, Graco offers systems, products and technology which set the quality standard in a wide range of fluid handling solutions. Graco provides equipment for spray finishing, protective coating, paint circulation, lubrication, and dispensing sealants and adhesives, along with power application equipment for the contractor industry. Graco's ongoing investment in fluid management and control will continue to provide innovative solutions to a diverse global market.

GRACO HEADQUARTERS

AMERICAS

MINNESOTA
Worldwide Headquarters
Graco Inc.
88-11th Avenue N.E.
Minneapolis, MN 55413

MAILING ADDRESS
P.O. Box 1441
Minneapolis, MN 55440-1441
Tel 612 623-6000
Fax 612 623-6777

MICHIGAN
Automotive Headquarters
and Sales Office
47800 Halyard Drive
Plymouth, MI 48170
Tel 734 416-3400
Fax 734 416-3441

EUROPE

BELGIUM
European Headquarters
Graco N.V.
Industrieterrein - Oude Bunders
Slakweidestraat 31
3630 Maasmechelen, Belgium
Tel 32 89 770 700
Fax 32 89 770 777

ASIA PACIFIC

JAPAN
Graco K.K.
1-27-12 Hayabuchi
Tsuzuki-ku
Yokohama City, Japan 2240025
Tel 81 45 593 7300
Fax 81 45 593 7301

CHINA
Graco Hong Kong Ltd.
Representative Office
Room 118 1st Floor
No. 2 Xin Yuan Building
No. 509 Cao Bao Road
Shanghai, P.R.China 200233
Tel 86 21 649 50088
Fax 86 21 649 50077

KOREA
Graco Korea Inc.
3rd Fl., Doorim Bldg.
164-21 Poi-Dong,
Kangnam-Ku
Seoul, Korea 135-260
Tel 82 2 575-8901
Fax 82 2 571-9422

Call today for product information or to request a demonstration.

1.877.84GRACO (1-877-844-7226) or visit us at www.graco.com.

All written and visual data contained in this document are based on the latest product information available at the time of publication. Graco reserves the right to make changes at any time without notice.

Graco Inc. is registered to I.S. EN ISO 9001

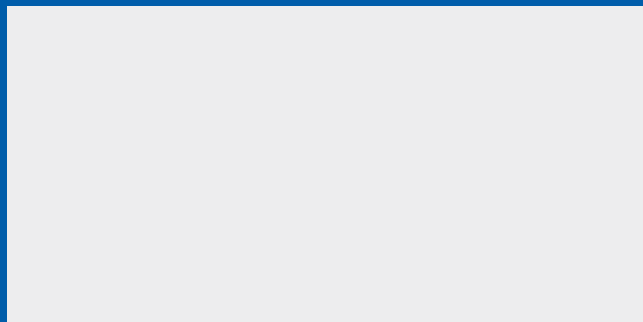

Sales/Distribution/Service North America

Industrial Customer Service
800-328-0211
FAX 877-340-6427
Industrial Product Information/Demonstration
1-877-84GRACO (1-877-844-7226)
FAX 612-378-3597

GRACO INC.
P.O. Box 1441
Minneapolis, MN 55440-1441

