

# FL SWITCH SF...

## Factoryline switches with standard functions



Data sheet  
3087\_en\_B

© PHOENIX CONTACT 2016-02-25

### 1 Description

The FL SWITCH SF... range of Factoryline switches with standard functions in numerous versions can be used for quick and cost-effective Ethernet network expansion. The switches have 8 or 16 ports, up to two of which are multi-mode glass fiber ports provided in the SC or ST format. The twisted pair ports of the switches support both Ethernet with a transmission speed of 10 Mbps and fast Ethernet with a transmission speed of 100 Mbps. The glass fiber ports only support 100 Mbps.

The switches regenerate received data telegrams and send them to the port to which the device is connected with the corresponding target address.

### 2 Features and fields of application

- Increased network performance by filtering the data traffic.
  - Local data traffic remains local.
  - The data volume in the network segments is reduced.
- Easy network expansion without configuration of the switch.
- Coupling copper network segments with different bit rates.
  - Automatic detection of the data transmission speed of 10 or 100 Mbps.
- Auto negotiation: Each copper port establishes a half or full duplex connection with 10 or 100 Mbps.
- Auto crossing: It is not necessary to make a distinction between 1:1 or crossover Ethernet copper cables.
- Electrical isolation of network segments using up to two fiber optic ports.
- Increasing the maximum cable length to 10,000 m (62.5/125  $\mu\text{m}$ ) or to 6400 m (50/125  $\mu\text{m}$ ) using a fiber optic port.
- Floating alarm output: The alarm output can be used to monitor the redundant voltage supply.
- Flow and back pressure control for high-quality communications.



Please note the different connection directions of the transmission media: Copper cables are connected at the **front**, glass fiber cables at the **bottom**.



Make sure you always use the latest documentation. It can be downloaded at [phoenixcontact.com](http://phoenixcontact.com).



This document is valid for all products listed in the "Ordering data" on page 2 and the referenced version. For versions (VC) prior to those listed, refer to data sheet 3087.

### 3 Ordering data

#### Products

Description	Type	Order No.	Pcs./Pkt.
Ethernet switch with 8 RJ45 ports (VC 14 and above)	FL SWITCH SF 8TX	2832771	1
Ethernet switch with 7 RJ45 ports and 1 fiber optic port in SC format (VC 9 (6) and above)	FL SWITCH SF 7TX/FX	2832726	1
Ethernet switch with 6 RJ45 ports and 2 fiber optic ports in SC format (VC 12 (8) and above)	FL SWITCH SF 6TX/2FX	2832933	1
Ethernet switch with 16 RJ-45 ports	FL SWITCH SF 16TX	2832849	1
Ethernet switch with 15 RJ45 ports and 1 fiber optic port in SC format	FL SWITCH SF 15TX/FX	2832661	1
Ethernet switch with 14 RJ45 ports and 2 fiber optic ports in SC format	FL SWITCH SF 14TX/2FX	2832593	1
Ethernet switch with 7 RJ45 ports and 1 fiber optic port in ST format	FL SWITCH SF 7TX/FX ST	2832577	1
Ethernet switch with 6 RJ45 ports and 2 fiber optic ports in ST format	FL SWITCH SF 6TX/2FX ST	2832674	1

#### Accessories

Description	Type	Order No.	Pcs./Pkt.
Rail adapter for mounting the 8-port switch at an angle of 90°	FL RA SF8	2832519	1
Universal end clamp	E/NS 35 N	0800886	50
RJ45 connector set; <b>gray</b> for 1:1 cables (pack of 2)	FL PLUG RJ45 GR/2	2744856	1
RJ45 connector set; <b>green</b> for crossover cables (pack of 2)	FL PLUG RJ45 GN/2	2744571	1
Double sheathed Ethernet cable	FL CAT5 HEAVY	2744814	-
Flexible Ethernet cable	FL CAT5 FLEX	2744830	-
Assembly tool for RJ45 connector	FL CRIMPTOOL	2744869	1
Patchbox 8 x RJ45 CAT5e, pre-assembled, can be retrofitted	FL PBX 8TX	2832496	1
Patchbox 6 x RJ45 CAT5e and 4 SC-RJ, glass pre-assembled, can be retrofitted	FL PBX 6TX/4FX	2832506	1
Patch cable, CAT 5, pre-assembled, 0.3 m long	FL CAT5 PATCH 0,3	2832250	10
Patch cable, CAT 5, pre-assembled, 0.5 m long	FL CAT5 PATCH 0,5	2832263	10
Patch cable, CAT 5, pre-assembled, 1.0 m long	FL CAT5 PATCH 1,0	2832276	10
Patch cable, CAT 5, pre-assembled, 1.5 m long	FL CAT5 PATCH 1,5	2832221	10
Patch cable, CAT 5, pre-assembled, 2.0 m long	FL CAT5 PATCH 2,0	2832289	10
Patch cable, CAT 5, pre-assembled, 3.0 m long	FL CAT5 PATCH 3,0	2832292	10
Patch cable, CAT 5, pre-assembled, 5.0 m long	FL CAT5 PATCH 5,0	2832580	10
Patch cable, CAT 5, pre-assembled, 7.5 m long	FL CAT5 PATCH 7,5	2832616	10
Patch cable, CAT 5, pre-assembled, 10.0 m long	FL CAT5 PATCH 10	2832629	10
Dust protection caps for RJ45 sockets	FL RJ45 PROTECT CAP	2832991	10

## 4 Technical data

### General data

Function	Switch/repeater; conforms to standard IEEE 802.3
Latency of the communication processor	6 $\mu$ s plus frame time (16-port version) 8 $\mu$ s plus frame time (8-port version)
Housing dimensions (width x height x depth) in mm	
8-port switch (RJ45)	135 x 80 x 30 (without COMBICON) 135 x 94 x 30 (with COMBICON)
8-port switch (fiber optics)	135 x 89 x 30 (without COMBICON) 135 x 103 x 30 (with COMBICON)
16-port switch (RJ45)	200 x 80 x 30 (without COMBICON) 200 x 94 x 30 (with COMBICON)
16-port switch (fiber optics)	200 x 80 x 30 (without COMBICON) 200 x 103 x 30 (with COMBICON)
Permissible operating temperature	0°C to 55°C
Permitted storage temperature	-20°C to 70°C
Degree of protection	IP20, DIN 40050, IEC 60529
Class of protection	Class 3 VDE 0106; IEC 60536
Humidity (operation)	5% to 95%, no condensation
Humidity (storage)	5% to 95%, no condensation
Air pressure (operation)	86 kPa to 108 kPa, 1500 m above sea level
Air pressure (storage)	66 kPa to 108 kPa, 3500 m above sea level
Preferred mounting position	Perpendicular to a standard DIN rail
Connection to protective earth ground	Snapped onto a grounded DIN rail
Weight	
8-port switch	263 g, typical
16-port switch	380 g, typical

### Supply voltage (US)

Connection	Via COMBICON; conductor cross-section 2.5 mm <sup>2</sup> , maximum
Nominal value	24 V DC
Permissible ripple	3.6 V <sub>pp</sub> within the permissible voltage range
Permissible voltage range	18.5 V DC to 30.2 V DC
Current consumption at US	Depends on the device - see the following table
Inrush current	9 A
Protection against polarity reversal	None
Test voltage	500 V DC for 1 minute
Power consumption	Depends on the device - see the following table

Module	Current consumption	Power consumption
FL SWITCH SF 8TX (<VC 14)	200 mA	4.80 W
FL SWITCH SF 8TX ( $\geq$ VC 14)	95 mA	2.28 W
FL SWITCH SF 7TX/FX (ST) (<VC 9)	220 mA	5.28 W
FL SWITCH SF 7TX/FX (ST) ( $\geq$ VC 9)	135 mA	3.24 W
FL SWITCH SF 6TX/2FX (ST) (<VC 12)	240 mA	5.76 W
FL SWITCH SF 6TX/2FX (ST) ( $\geq$ VC 12)	75 mA	4.20 W
FL SWITCH SF 16TX	300 mA	7.20 W
FL SWITCH SF 15TX/FX	330 mA	7.92 W
FL SWITCH SF 14TX/2FX	360 mA	8.64 W

## Interfaces

Total number of Ethernet interfaces	8/16
<b>Properties of RJ45 ports</b>	
Number	6, 7, 8, 14, 15 or 16 depending on the device version
Connection format	8-pos. RJ45 socket on the switch
Connection medium	Twisted pair cable with a conductor cross-section of 0.14 mm <sup>2</sup> to 0.22 mm <sup>2</sup>
Cable impedance	100 Ω
Transmission speed	10/100 Mbps
Maximum network segment expansion	100 m
<b>Properties of fiber optic ports</b>	
Number	0, 1 or 2 depending on the device version
Connection format	SC duplex socket or ST socket on the switch
Wavelength	1300 nm
Laser protection	Class 1 according to DIN EN 60825-1:2001-11
Minimum transmission length, including 3 dB system reserve	5.7 km glass fiber with F-G 50/125 0.7 dB/km F1200 2.5 km glass fiber with F-G 50/125 1.6 dB/km F800 10 km glass fiber with F-G 62.5/125 0.7 dB/km F1000 2.9 km glass fiber with F-G 62.5/125 2.6 dB/km F600
Average transmission power (fiber type) in link mode <sup>1</sup>	-22.5 dBm (50/125 μm) / -19 dBm (62.5/125 μm)
Minimum receiver responsiveness	-31 dBm (dynamic)
Maximum overrange	-14 dBm (dynamic)
Transmission speed	100 Mbps
<b>Alarm contact</b>	
Voltage	24 V DC, typical
Current carrying capacity	100 mA, typical

<sup>1</sup> Distance calculations assume a link budget of 4 dBm (50 μm fiber), 7.5 dBm (62.5 μm fiber), 3 dBm margin, and 1.5 dBm for connectors

## Mechanical tests

Shock test according to IEC 60068-2-27	Operation: 25g, 11 ms period, half-sine shock pulse Storage/transport: 50g, 11 ms period, half-sine shock pulse
Vibration resistance according to IEC 60068-2-6	Operation/storage/transport: 5g, 150 Hz, criterion 3
Free fall according to IEC 60068-2-32	1 m

## Conformance with EMC directives

Developed according to IEC 61000-6-2	
IEC 61000-4-2 (ESD)	Criterion B
IEC 61000-4-3 (radiated-noise immunity)	Criterion A
IEC 61000-4-4 (burst)	Criterion A
IEC 61000-4-5 (surge)	Criterion B
IEC 61000-4-6 (conducted noise immunity)	Criterion A
IEC 61000-4-8 (noise immunity against magnetic fields)	Criterion A
EN 55022 (noise emission)	Class A

## Approvals

CE	
	Class I, Div. 2 E199827
UL508	E140324
ROHS	EEE 2002/95/EC, WEEE 2002/96/EC

## 5 Dimensions

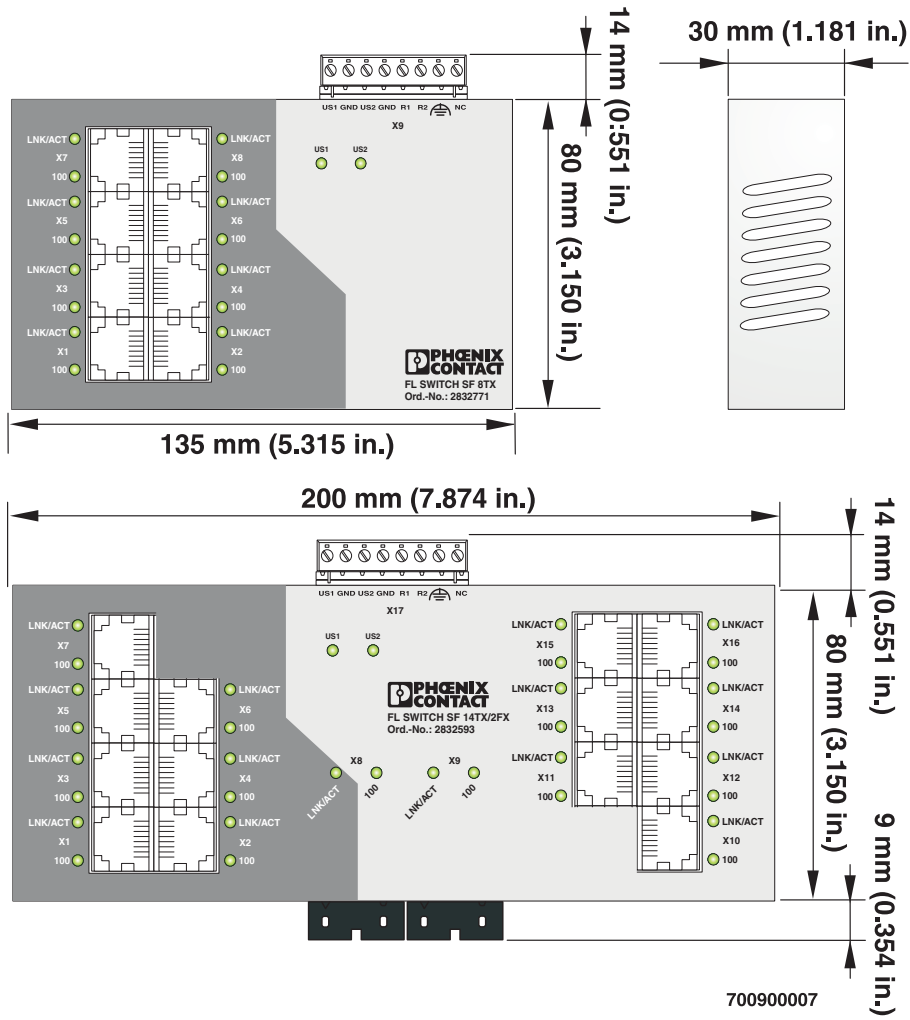

Figure 1 Dimensions

## 6 Housing versions and position of the fiber optic connections

The housings of the 8-port versions are identical. On the fiber optic versions, the connections for the fiber optic ports are at the **bottom** (see also Figure 3).

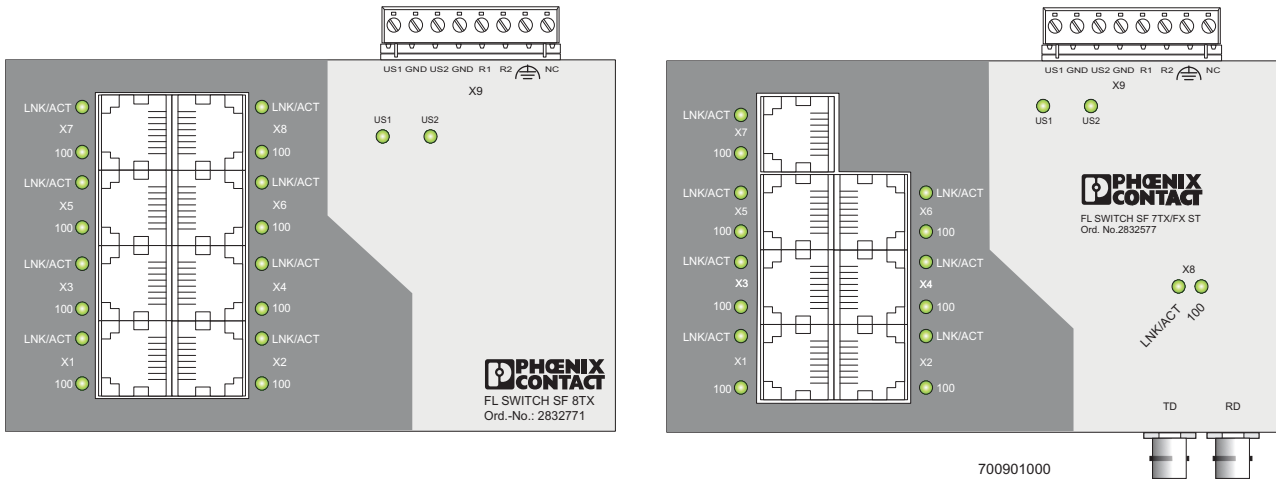

Figure 2 Housing examples for 8-port switches - FL SWITCH SF 8TX (left)/FL SWITCH 7TX/FX ST (right)

The housings of the 16-port versions are identical. On the fiber optic versions, the connections for the fiber optic ports are at the **bottom**.

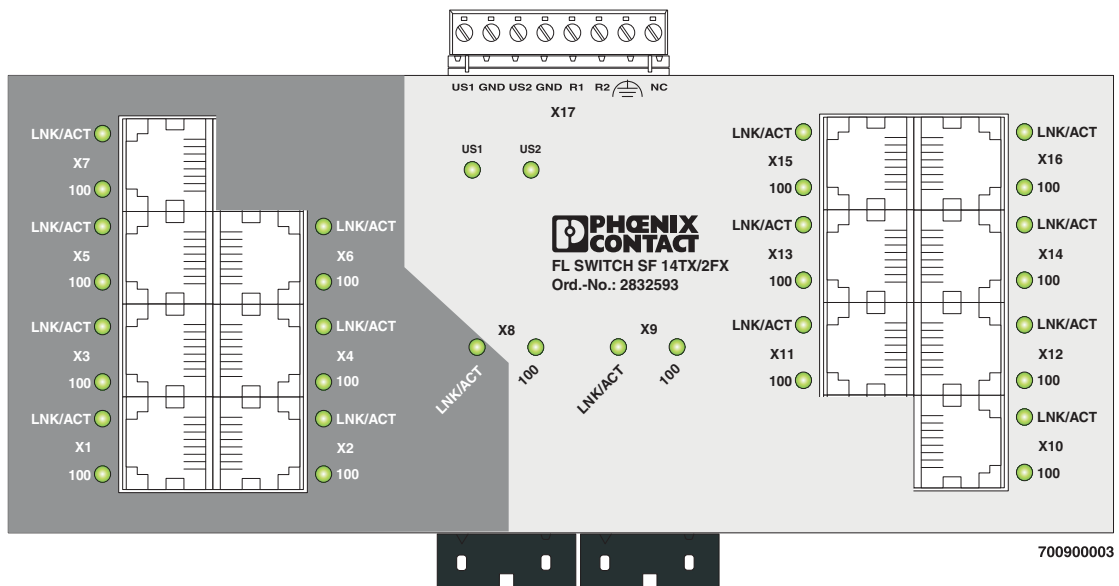

Figure 3 Housing example for 16-port switches (FL SWITCH 14TX/2FX)

## 7 Local diagnostic and status indicators

Des.	Color	Status	Meaning
US1	Green	On	Supply voltage US1 in the tolerance zone
		Off	Supply voltage US1 too low
US2	Green	On	Supply voltage US2 in the tolerance zone
		Off	Supply voltage US2 too low
One LED per port			
LNK/ACT	Green	On	Link active
		Flashing	Active telegram
		Off	Link not active
100	Yellow	On	Data transmission speed 100 Mbps
		Off	Data transmission speed not 100 Mbps

## 8 General information



### CAUTION:

Disregarding this warning may result in damage to equipment and/or serious personal injury. Only qualified personnel may start up and operate this device. According to the safety instructions in this text, qualified personnel are persons who are authorized to start up, to ground, and to mark devices, systems, and equipment according to the standards of safety technology. In addition, these persons must be familiar with all warning instructions and maintenance measures in this text.



### NOTE:

The FL SWITCH SF... module is designed exclusively for SELV operation according to IEC 950 / EN 60950 / VDE 0805.



### WARNING: EXPLOSION HAZARD

- Do not disconnect equipment unless power has been switched off or the area is known to be non-hazardous.
- This equipment is an open-type device meant to be installed in an enclosure suitable for the environment, and must only be accessible with the use of a tool.
- This equipment is suitable for use in Class I, Division 2, Groups A, B, C, and D, or non-hazardous locations only.
- Substitution of components may impair suitability for Class I, Division 2.
- Exposure to some chemicals may degrade the sealing properties of materials used in the sealed relay device.

## 9 Installation

Install the FL SWITCH SF... module on a clean DIN rail. To avoid contact resistance only use clean, corrosion-free DIN rails. End clamps can be mounted on both sides of the module to stop the modules from slipping on the DIN rail.



Connect the DIN rail to protective earth ground using a grounding terminal block. The modules are grounded when snapped onto the DIN rail. Connect protective earth ground with low impedance.

### 9.1 Mounting

1. Place the module onto the DIN rail from above. The upper holding keyway of the module must be hooked onto the top edge of the DIN rail.
2. Push the module from the front towards the mounting surface.
3. Once the module is snapped on properly, check that it is fixed securely on the DIN rail.

### 9.2 Removal

1. Insert a suitable tool (e.g., needle-nose pliers) into the arresting latch and pull it down.
2. Pull the module slightly away from the mounting surface.
3. Lift the module from the DIN rail.

### 9.3 Terminal assignment

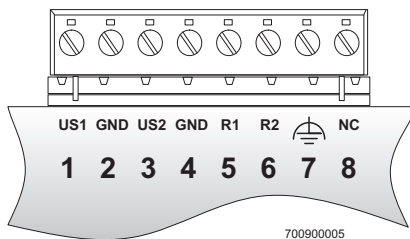

Figure 4 Terminal assignment

Terminal	Meaning
1	Supply voltage +US1
2	GND US1
3	Supply voltage +US2
4	GND US2
5	Alarm contact 1 (R1)
6	Alarm contact 2 (R2)
7	Functional earth ground
8	Not connected

### 9.4 Connecting the supply voltage



The module is operated using a +24 V DC SELV. The module is fully operational even with only one supply voltage (without jumpering it to other supply voltage terminal blocks) and/or without wiring the alarm contact.

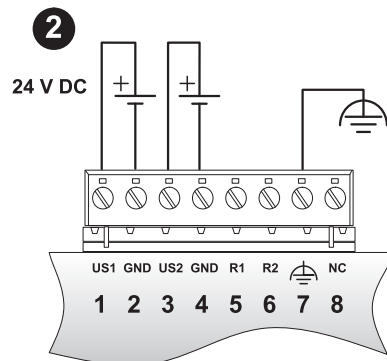
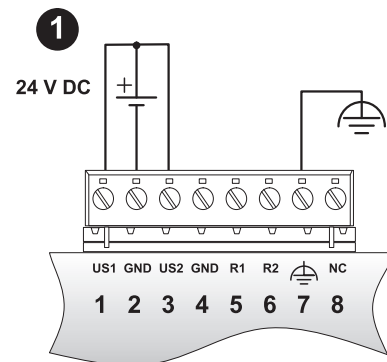

Figure 5 Typical supply of the module from one or two voltage sources

#### Supplying the module from one voltage source



The alarm contact is open if voltage is present at both supply voltage terminal blocks US1 and US2. In the event of an error at one of the two voltage sources, the contact is closed. If the voltage is not supplied redundantly, terminal blocks US1 and US2 must be jumpered (see Figure 4, version 1), so that the voltage can be monitored via the alarm contact.



**Option:** In addition, noise immunity can be increased in environments subject to high EMI by a low-impedance connection to functional earth ground via terminal block 7.



### 9.5 Ethernet interface

The FL SWITCH SF... module has up to sixteen Ethernet ports on the front in RJ45 format, to which only twisted pair cables with an impedance of 100 Ω can be connected. The data transmission speed is 10 Mbps or 100 Mbps. In addition, each port has an auto crossing function: It is not necessary to make a distinction between 1:1 or crossover Ethernet cables.

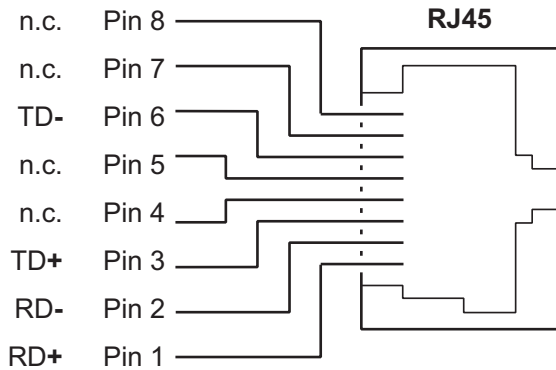

Figure 6 Pin assignment of the Ethernet ports in RJ45 format

### 9.6 Switching features of the FL SWITCH SF...

#### Store and forward

All data telegrams received by the switch are stored and checked for validity. Invalid or faulty data packets (> 1536 bytes or CRC errors) and fragments (< 64 bytes) are rejected. Valid data telegrams are forwarded by the switch. The switch always forwards the data using the data transmission speed used in the target network segment.

#### Multi-address function

The switch automatically learns the addresses of termination devices, which are connected via the port, by evaluating the source addresses in the data telegrams. Only packets with unknown addresses, with a source address of this port or with a multicast/broadcast address in the target address field are forwarded via the corresponding port. The switch can store up to 1k (8-port version) or 8k (16-port version) addresses in its address table with an aging time of five minutes. This is important when more than one termination device is connected to one or more ports. In this way, several independent subnetworks can be connected to one switch.



A restart deletes the entire address table.

### 10 Mounting option

Using the FL RA SF8 rail adapter the 8-port SF switches can also be mounted on the DIN rail at an angle of 90°. In addition, the switch can be fixed on the DIN rail using the E/NS 35 universal end clamp.

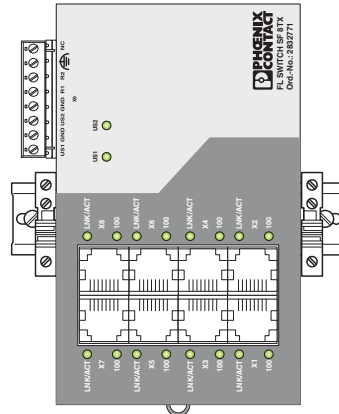

Figure 7 FL SWITCH SF 8TX rotated 90° and DIN rail-mounted